

# Operating manual for tipping bodies S3, S2

## Abridged instruction for driver



**VS-mont spol. s r.o., Panština 1030, 020 55 Lazy pod Makytou**  
tel.: +421 / 42 / 431 35 11, fax: +421 / 42 / 431 35 16  
[www.vsmont.sk](http://www.vsmont.sk), [vsmont@vsmont.sk](mailto:vsmont@vsmont.sk)

**Dear customer,**

thank you for Your decision and congratulations on Your purchase of the vehicle/tipping body of the brand VS-mont.



# Operating manual for tipping bodies

## Type VSPN, variant S3, S2

The tipping body is designed for transportation of various types of materials with the possibility of three-way tipping. The tipping of the loading area is provided by using hydraulic system from the company HYVA (or from other supplier), controlled from the driver's cabin. Hydraulic system connection with description of constituent components is in the picture on page 6 – Standard tipping set S2, S3 – type KIC CZ-0304.

It is necessary to keep the following procedure for lifting and tipping the body:

**Steel securing pins (2 pieces) are supplied to each tipping body**

**When tipping backwards, only REAR pins must be secured**

**When tipping to the side, only SIDE pins must be secured**

1. Switch on the hydraulic pump using the PTO switch located in the driver's cabin. The clutch pedal must be pressed during switching the pump on and off.
2. Tipping backwards. ATTENTION: Before tipping the loading area BACKWARDS, the tailgate must be released by using the switch located on the dashboard (picture 2), which controls the pneumatic cylinders - during pneumatic releasing. By mechanical releasing, the tailboard is released automatically during lifting of the superstructure.
3. Tipping to the side “**pendel**”: By mechanically secured sidewalls, it is necessary to release the lever of the sidewall opening, which is located on the front face or on the side pillars. After tipping the body, it is necessary to once again secure the sidewall with the lever.

Tipping to the side “**hydraulic sidewall**”:

By hydraulically secured sidewalls, it is necessary:

- to switch on the pump (point 1)

- to start to control the hydraulic sidewall by means of the lever switches (picture 3)

Opening of the sidewall “**pallet**”: When loading pallet or other material using a forklift, it is necessary to release the locking levers located in the side pillars and lower the sidewall to the lower position.

ATTENTION: BY higher and heavier sidewalls, it is necessary to use the forklift for the tipping!

After the sidewall has been tipped, it is necessary to secure the sidewall again with the lever.

**By tipping the sidewall in the way "pallet" is not allowed to tip with the body as this could result in a collision of the sidewall (or its parts) with the chassis.**

4. For lifting the loading area, it is necessary to switch on the PTO of the vehicle - point 1. Lifting of the loading area is operated by using the lever on the control next to the driver's seat. It is necessary to keep the lever of the lifting operation in the upper position during lifting of the loading area. After reaching the final position of tipping, the final switch automatically switches off the hydraulic circle.
5. During the tipping of the loading area into the idle position, using the lever for control of lifting, which is moved to the lower position, the hydraulic circle switches on and the loading area will return to the neutral (idle) position. After returning the loading area to the idle position using the switch for control of the tailboard, situated on the panel to the right of the driver, secure the tailgate (valid for pneumatic securing).  
By mechanical securing, the tailgate is secured automatically.  
After return of the loading area to the idle position, switch off the hydraulic pump.
6. The final positions of the lifting of the loading area are secured with the final switch, which is located on the hydraulic cylinder. The direction of the tipping is determined by the position of securing pins in the forks of the loading area.
7. Mechanical holder of spare wheel: the spare wheel must be unscrewed from the tipping body and then, using a winch, place it on the ground.

Hydraulic spare wheel holder:

- a) release the spare wheel,
  - b) switch the lever on the manual hydraulic pump to the right and, using the pump lever, remove the spare wheel from the securing screws,
  - c) after removing the spare wheel off the securing screws, regulate the speed when lowering the spare wheel using the lever on the pump. Turning the lever to the left decreases the speed of lowering.
  - d) by lifting the spare wheel, switch the lever to the left and, using the lever, lift the spare wheel onto the securing screws,
  - e) after lifting the spare wheel, secure it with nuts.
8. Control of trailer:
- switch on the pump,
  - using the control (picture 3), control the loading area on the trailer.
- Switching off the lifting function is carried out by switching off the PTO and TRAILER switches. Loading beds must be returned to the idle position.
9. Before each working activity, it is necessary to inspect the condition of the hydraulic system (escape of oil, damage to hoses, etc).
10. In case of necessary repairs under the lifted loading area, this must be secured using a brace which is located on the bottom of the loading area. The maximum working pressure of the hydraulic system is 190 - 250 bar. (depending upon the type of used hydraulic circle)
11. Before each driving the vehicle it always is necessary to perform a visual inspection of the tightness of the hydraulic system.
12. All the lubricants on the tipping body and the hydraulic system have to be lubricated once per month and check the condition of the hydraulic oil on the oil mark, situated on the oil tank behind the driver's cabin, should be inspected. The lubricants on the ball bearing on the bottom of the loading area should be lubricated monthly. It is necessary to regularly clean the lifting limiter of mud and dirt, and lubricate the moving parts with graphite vaseline + once per month lubricate with graphite vaseline the switching pin placed under the rubber cover which is part of the pneumatic valve and thereby part of the entire lifting limiter.
13. The following type of hydraulic oil is used in the hydraulic system: OHHM 15 – 45 (according to the region).
14. Recommended replacement of the hydraulic oil which can be combined: see Operating and maintenance instructions – HYVA
15. The service station must be consulted regarding possible looseness of hydraulic cylinder.
16. Stabilising factors during the tipping are:
- firmness of the body
  - tipping axis
  - chassis - frame
  - suspension springs
  - tyres
- Therefore, these parts must always be in good condition and tyres must be properly inflated. Tipping must be carried out in a flat terrain, which is sufficiently firm to hold the weight with the load and care must be taken to avoid increased loading of the rear axle.
17. High revolutions of the engine during the tipping can cause high speed of the lifting of the cylinder and therefore it can be damaged. It is generally valid, that the transfer from the pump to PTO = 0.8 max. allowed revolutions can be 1500
- 1 max. allowed revolutions can be 1200
  - 1,2 max. allowed revolutions can be 1000
18. We do not provide any guarantee for damage caused during operation by neglect or lack of knowledge during maintenance (operation).

## IT IS FORBIDDEN:

- to overload
- to change anything in the hydraulic system or to adjust pressure
- to tip on an uneven or an infirm surface
- to stand and work under a lifting tipper
- when the tipping body is lifted up, it is forbidden to move the chassis

**! WARNING: A tipping body of this type is not suitable for driving in an extremely uneven terrain and non-reinforced roads due to possible damage of the tipping body!**

## ABRIDGED INSTRUCTION FOR DRIVER

### 1. Operating instruction

#### 1.1 PTO (Power Take Off = secondary drive from the gearbox)

*Tip: If there already is PTO from the production on your vehicle, then check the user manual or consult it with the manufacturer.*

The PTO drives the pump and so the whole hydraulic system. Normally it is pneumatically (airpressure) controlled and has two positions

0 – off    1 – on

In the “on” position the PTO and pump are activated. Control lamp on the control is on.

**! ATTENTION: The PTO must be switched on, when the car is not moving.**

#### I. Switch on the PTO

Every vehicle manufacturer has the switch on of PTO, in the most cases it is located direct on the vehicle dashboard (example picture 1)



Picture 1 – Original switching on the PTO

Stop the vehicle into the parking position. Put the gearbox in neutral position. Press the clutch and wait about 5 seconds. Check if the indicator lamp illuminates and slowly release the clutch pedal. The PTO is now switched on.

**! WARNING: Do not drive with the PTO switched on.**

#### II. Switch off the PTO

With the tipping control in neutral position, press the clutch. Switch off the PTO by switching the lever to the required position. The indicator lamp switches off. Slowly release the clutch. The PTO is now off.

## 1.2 Unsecuring, securing and lifting the tailgate

The tipping bodies VS-mont can be equipped with:

„**Mechanical**“ - automatic unsecuring of the tailgate – the tailgate is unsecured automatically by lifting the body and it secures automatically by tipping the body.

“**Pneumatic**” - manual unsecuring of the tailgate, here it is necessary to unsecure the tailgate before tipping backwards by means of the control on the dashboard and to secure the tailgate after the tipping by means of this control. Informative picture ( the location can change by various producers).



Picture 2 - releasing of the tailgate

## 1.3 Tipping of the body:

The tipping control in the cabin (older design)



Picture 3

New design

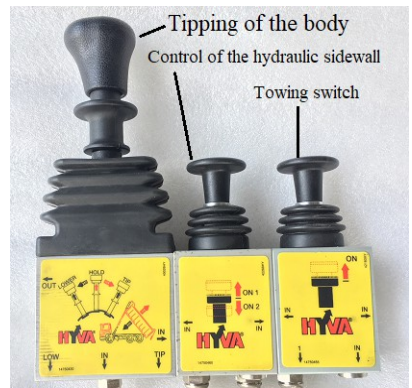

The air control pneumatically activates the tipping valve, which opens the flow of oil. The air control has three positions (see picture 3), middle - "neutral", which holds the body in definite position, lever up - „lifting the body“, lever down – „descent the body“.

## Lifting of the body

Switch off the control into the position „lifting of the body“, the hydraulic oil starts to fill the system, to extend the cylinder and to tip the body. The tipping can be interrupted at any time by switching the control into the "neutral" position.

## Neutral

In "neutral" the oil circulates into the tank and the cylinder remains in the position in which it was stopped.

## Lowering the body

When the control is switched into the position "lowering the body", hydraulic oil returns from the cylinder to the tank, the cylinder is retracting and the body is slowly lowering.

## Sidewall locks – securing and unsecuring

Your vehicle can be equipped by mechanical, pneumatic or hydraulic sidewall locks.

Mechanical locks must be released and locked manually by means of a lever on the front face.

Pneumatic locks must be released and locked by means of a switch on the dashboard.

Hydraulic unsecuring and opening of the sidewall is realized by means of a joystick, picture 3.

**ATTENTION: generally by opening the sidewall, but especially by hydraulic control of the sidewall, it is necessary to ensure, that when opening and closing the sidewall there is no one in the opening space of the side (otherwise there is a risk of injury / death !!!).**

**! ATTENTION: the sidewall locks must be secured, when the vehicle is not in use.**

## Switch Car/Towing vehicle (picture 3)

It switches the control from the mode of the body of the vehicle to the mode of the control of the body on the towing vehicle (if it is in the equipment).

### 1.4 Tipping and lowering the body (for more details see Safe tipping instructions)

#### 1.4.1 Tipping in general

**! ATTENTION: Ensure always your own view of the process of tipping and do not rely on other people. Before tipping the body, make sure that nobody is in the working area of the tipper (also for case of overturning).**

**Beware of instability of the vehicle due to the contents sticking or freezing, or uneven distribution of the load. The base on which the vehicle is standing during the tipping must be stable and the vehicle must stand firmly on the ground in all directions.**

Enclosed diagrams clearly show how to use a tipper.

**Jump out of the cabin when tipping body gets in contact with high voltage wires.**

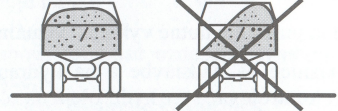
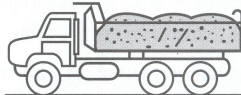

**Do not jump out of the cabin from an overturning vehicle.**

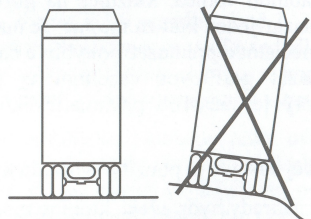
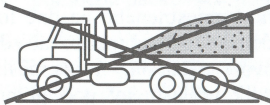

**Increased caution is the best way to avoid accidents.**

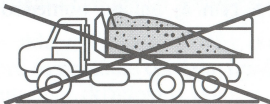

**During the tipping on a hill, the cabin of the vehicle must always, when tipping backwards and to the side, be facing uphill or downhill and its axles must stand horizontally, to avoid any pressure on the tipping cylinders from the sides.**

**! ATTENTION when tipping backwards:**

- a) when the vehicle is in a position with the cabin facing downhill, there will be problems with tipping and unloading the load (the angle with the horizon will be reduced and the cylinder will be weak) or
- b) when the vehicle is in a position with cabin facing uphill, during tipping it is necessary to finish tipping of the body before the cylinder reaches the lifting limiter (otherwise the vehicle will overturn).

**High revolutions of the engine during tilting can cause the cylinder to eject at high speed and therefore it will be damaged. Maximum allowed engine revolutions when tilting are set according to the bodybuilder for this vehicle as follows:  
maximum .....revolutions/1 minute.**

If it is necessary due to releasing of the load from the loading bed, the vehicle can be slowly moved, max. 2 - 3 m, during the tipping with the body in the upright position, but the driver must not jerk the vehicle i.e. accelerate quickly and brake sharply.

**As soon as the body is empty, it is necessary immediately without any further vehicle move, to lower the tipping body to the chassis and to wait about one minute before you switch the control into the position „neutral“.** Do not drive with the control lever in the position „lowering“, as this will allow all of the oil to drain from the cylinder.

If there is a trailer connected to the motor vehicle, **trailer and motor vehicle must be in one line during the tipping.** The same applies to towing vehicle with semi-trailer.

### ***1.4.2 Tipping backwards***

**! ATTENTION: Tipping with a locked (secured) or blocked tailgate is danger to life. The unsecured bearings of the body are danger to life by tipping backwards, so make sure, that both pins are at the rear.**

Remove any sheeting of the load. If there is a risk it may foul up the tailgate, restrict the discharge of the load during the tipping. Switch the control into the „tipping“ position. Switch the control to “neutral” at the end of cylinder stroke restricted with limiter.

### ***1.4.3 Tipping to the side (2- and 3-way tipping bodies)***

By this using it is possible to tip the load to one or to the other side, as necessary.

**! ATTENTION: The bearings of the body, which are not secured by pins are danger to life, please check, if both pins are on the side of the tipping .**

Check if there is one hinge pin at the front and one at the rear on the side you wish to tip. Release the side walls and open them. The body can now be tipped in the same manner as a rear tipper.

### ***1.4.3. Lowering the body***

The proportional control, tipping valve and tipper-control make it possible to control the lowering speed of the tipping body. Disengage the PTO. Put the control slowly into the position “lower”. As soon as tipping body is lowered on the chassis, wait about 1 minute before you switch the control to the position „neutral“.

**! ATTENTION: Before driving, always make sure all locks are properly secured.**

**When loading, make sure the load is evenly spreaded on all lenght and width of the body.**

## 1.5 Hydraulic system

### Standard tipping set S2, S3 – type: KICCZ-024

Hydraulic system consist of hydraulic tank (066L/052L), hydraulic pump (052L), selector valves, hydraulic cylinder and pneumatic control.



### HYDRAULIC OIL

The hydraulic oil used in the hydraulic set is FUCHS - RENOLIN OHM 15 - 46

Recommended replacements of hydraulic oil which can be combined: see the HYVA Operating and maintenance instructions

## HYVA HYDRAULIC KIT

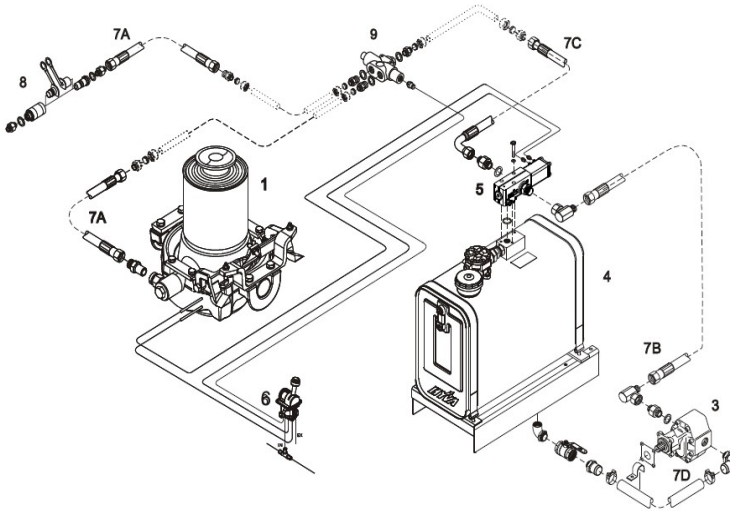

Part list

Pos	Part. no	Description	Qty
1	1412615	KRM (set with pneumatic limiter)	1
3	CB091BD	Gear pump 092L-BI-4H	1
4	DC079MFAD	Oil tank CM100L/079L-MP-RF	1
5	14767328	Tipping valve PT 1220 – 280 bar	1
	NK1612R	Nippelkit 3/4" d – 1" d	1
	14799054	Kit 1" D – 3/4" d	1
6	FC151A	Air control for valve / diverter valve	1
7A	14790014	H.P. hose 3/4" – L = 700 mm	2
7B	14790040	H.P. hose 3/4" – L = 2000 mm	1
7C	14790038	H.P. hose 3/4" – L = 1500 mm	1
7D	GM100AB	Suction hose 1 3/4" – L = 2500 mm	1
8	L041-06	Q.R. coupling 3/4"	1
9	14708612	Diverter valve 3/4" truck / trailer	1

## 2 Accident instruction

- 2.1 In case of hydraulics failure, do not move anything!
- 2.2 Ensure attendance of VS-MONT / HYVA service personnel (in case of rejected claims the cost will be charged to vehicle users).
- 2.3 Call VS-MONT/HYVA service personnel to the accident site.



- 2.4 The attending service technician shall take photographs of: the accident site, the tractor – number plate and VIN, the trailer – number plate and VIN, damage of the cylinder of the semitrailer or the tractor, overall situation, ground at the place of tipping, ...
- 2.5 Copy labels of all components within the hydraulic system (not only HYVA).
- 2.6 Ensure inspection at the HYVA authorized service point to perform detailed defect identification (VS- MONT / HYVA shall not cover the cost associated with transport of the vehicle to the service point, not even in case of claim approval).
- 2.7 Ensure order for repair of VS-MONT / HYVA components in case of claim rejection.
- 2.8 Further procedure shall conform to the Service Conditions (see section 3. of Service Instructions), Warranty Conditions and the General Conditions set forth by VS-MONT / HYVA.

### **3. Service instruction to the hydraulic system HYVA**

- 3.1 HYVA provides service activities by means of contractual service workshops in conformance with Warranty Conditions of the HYVA included in the Complete Tipper Operation and Maintenance Manual and the General Conditions of HYVA.
- 3.2 Contractual service workshops ensure identification of causes and status of damage on HYVA goods, in the most ideal case this be done directly at customers, by means of service workshops or service vehicle.
- 3.3 Prior to departure of the service vehicle, the contractual workshop personnel shall supply their customer with this information by fax including a notification saying that, if the claim is not approved, its cost shall be charged to the customer, and the order of service vehicle shall be confirmed.
- 3.4 The contractual service will fill its finding concerning causes and damage into the claim protocol same as the proposed solution and such protocol shall be sent to HYVA immediately.
- 3.5 HYVA shall review the claim protocol and the solution proposed by the contractual service and it shall be decided, whether the particular claim can be approved or not.
- 3.6 The review of claim protocol shall be performed:
  - 3.6.1 without the need of HYVA to inspect the item; or
  - 3.6.2 by means of visit to the customer or a contractual service workshop paid by authorized person or engineer from HYVA; or
  - 3.6.3 the damaged item shall be sent to HYVA-Group upon request of HYVA.
- 3.7 Solution: The goods shall be either repaired or replaced with reworked or new goods from warehouses or they shall be ordered from the HYVA-Group.
- 3.8 If the new or reworked goods were to be provided to the customer prior to issuance and review of the claim protocol or completion of a repair (including issuance of a repair protocol), the customer shall first pay the price of replacement goods or/and repair, only then the replacement goods or repair may be provided and following completion of such repair or with respect to the result of claim protocol review the paid amount might be refunded.
- 3.9 The contractual service shall conduct repairs in its central workshop or by means of service vehicle upon agreement concluded between HYVA and the particular customer.
- 3.10 The service after warranty shall adopt a similar procedure to the above mentioned warranty service, i.e. there shall be one difference: HYVA will not have to review claim protocols or statements in case of after warranty activities, unless exclusively stated, e.g. in case of accident.
- 3.11 In case of accidents the contractual service shall be obliged to receive the statement of HYVA and permission from the HYVA's insurance agent prior to provision of service works.

## 4. Maintenance instruction

**! ATTENTION: Maintenance activities in the vicinity of moving parts are hazardous. If the platform is lifted for maintenance, it shall be always locked in position properly. Presence of persons under lifted platform is in hazard of life.**

### Maintenance plan of hydraulic system and tipping body

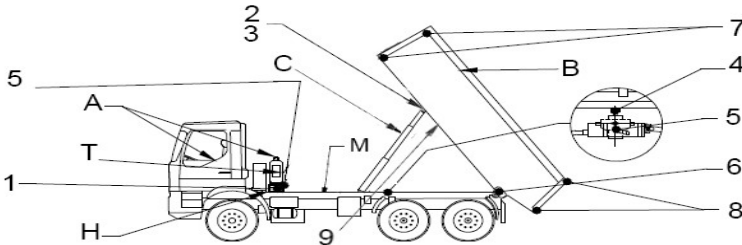

Type	Description	Application	Perform always 1x:		
			Daily	Weekly	Semiannually, yearly
Maintenance	(A) Air	Air distribution Air control	Control on damage and leak Control on air working, damage and leak	Control on damage and leak	
	(H) Hydraulic system	Entire system Pump Hydraulic distributions Hydraulic valves	Cylinder control on working, damage, leak Control on damage and leak Control on damage and leak	Clean the cylinder Control on tightness	
	(T) Tanks	Oil level Oil filter Air filter Entire tanks Entire tanks Attachment	Check and fill in if missing *	Control the filter cleanness Control the air filter  Control nuts and screws (tightness)	Change oil filter Change air filter Change oil Clean tank interior
Greasing period	(C) Cylinders	Entire cylinders FC types FE types DCT/UCB types DCT/UCB and FC/FE		1. Grease attachment to the chassis 2. Grease attachment 3. Grease eye under tipping body 4. Grease piston bearing 5. Grease bearing	
	(B) Tipping body	All types 1-way tippers 3-way tippers (if fitted)	Visual control of tipping body Lock-off mechanism adjustment  Control of possible cracks	6. Grease rear hinges 6. Grease front hinges 7. Grease rear and side door mechanism  Grease all nuts	9. check rubber stops regularly, if damaged, replace them immediately
	(M) The rest	Attachment of body Stabiliser		8. Grease the attachment of body Grease main stabiliser (3x)	

Report immediately any tipper damage to tipper producer to remove the damage.

Note: Never use vapour to clean hydraulic components (cylinders, valves, hoses). \* Read about recommended oils!

# SAFETY TIPPING INSTRUCTIONS

## DRIVER'S RESPONSIBILITY WHEN TIPPING:

- **Always** report yourself to the caretaker or owner of the construction site at arrival, claim operating instructions for this construction site and keep them.
- **Always** tip and load on places and at times given by the customer.
- **Always** remember, only driver is responsible for vehicle safety while tipping. If you are not sure on load unloading, or if it is not possible to agree with construction site caretaker, contact your employer about unloading.
- **Never** tip the material out of the tipper body until you are sure the vehicle can not overturn when tipping.
- **Always** make sure vehicle is located on a firm ground, if possible not downhill. Make sure vehicle shall remain on firm ground even if it will be moved forwards.
- **Always** make sure the tipping semi-trailer is in one line with the towing vehicle.
- **Make sure** before tipping operation nobody stands near vehicle and nobody can be endangered even if vehicle overturns.
- **Always** make sure before tipping, that tailgate is opened.
- **Never** stand or walk right behind vehicle with lifted tipper body or behind vehicle during tipping the load.
- **Never** leave vehicle when tipping and make sure all cabin doors are closed safely.
- **Always** pay attention to possible obstacles, especially to high voltage wires. Do not await you will be noticed about these obstacles by construction site caretaker. If tipper bed shall touch electric wires, tipper must be lowered immediately. If you are unable to do so, jump immediately out of the vehicle, beware you must not touch the vehicle and earth at one time because thereby electric circuit would be closed. Don't allow anybody to close to vehicle when it is touching the electric wires. Call electric plant emergency service immediately.
- **Remember** electric discharge can overleap relatively great-long distance. Be therefore utmost cautious when tipping near electric line.
- **Always** when the load is higher than the tailgate, make sure the load can not get stuck on it, because under given circumstances tipper bed can tear off from the piston and tipper overturns rearwards under the weight of stucked load.
- **AIR CONTROL:** automatic PTO exclusion prevents excessive wear on the PTO and ensures that this device is not driven, when the vehicle is in motion.
- **Remember** when you start tipping the load and the tipping angle is not 20° (i.e. at about half lifted tipper bed), stop tipping operation and check the cause. In such situation walk in sufficient distance from the vehicle.
- **Never** try to loose the load through jerky movements of the vehicle forwards and rearwards.
- **Remember**, when vehicle overturns, it is much more safe to stay in the vehicle cabin. Support yourself strong against driver's seat and hold the steering wheel. Never try to leave vehicle when it begins to overturn.
- **Do not forget** to return the lever of „tipping“ operation to neutral position in the moment when the tipping body is lifted to its maximum.
- **Never forget** to make sure, that PTO is switched off after the tipping operation has been finished.
- **Never** turn the engine revolutions to high output when tipping, this could cause oil underpressure on pump suction and following it can be damaged.
- **Do not forget** to make yourself sure the tipping body is absolutely empty. Always put the loading area in position downwards before you leave construction site, remove possible obstacles and secure tailgate.

## DRIVER'S RESPONSIBILITY WHEN LOADING:

- **Always make sure** persons loading your vehicle are in charge and they will load material on your vehicle safely. If you doubt, ask the owner or caretaker of the construction site, if they have adequate experiences.
- **Always make sure** the load is evenly spreaded across all the tipping body space to avoid overturning of the vehicle to side during tipping operation and to ensure equilibrium load on axis. Tipping device can be damaged when the load is too much at front.
- **Never** stand near vehicle when loading or parking in area of loading. Never stand on vehicle when loading.
- **Pay attention to** load that can easily freeze or stick, for example wet sand or gravel. Load frozen on one tipping bed's side can cause vehicle overturning during tipping.
- **Pay attention to** loads with various density. If bigger parts of material start to pour out first and small parts remain in the vehicle stucked together and they do not pour out, vehicle can loose its balance and become unstable.

## VEHICLE KEEPER'S RESPONSIBILITY

- **Never** work on vehicle with lifted tipper bed without corresponding support. All safety standards related to stability when tipping valid for drivers are equally valid for serviceman and mechanics.
- **Always** check and grease all hinges and pistons during regular inspections. Make sure all hose connections are in good condition and proper connection and the liquid does not leak. Hydraulic liquid can cause health problems and endanger environment, it must not leak from closed system.
- **Always** check if hydraulic hoses are not swollen and if they do not rub against bodywork.
- **Regularly** check if there are not any sharp parts protruding out of the bodywork that could injure around walking people or construction site employees. Make sure sealing round tailgate is in good condition and material can not leak after it is closed.
- **Always** check after tipping or driving in terrain if vehicle's rear lights are not damaged.
- **Always** use only authorized supplier for all parts necessary for piston repair or renewal. Make sure all sealings are delivered in original closed package marked by producer.

## SERVICEMAN AND MECHANICS RESPONSIBILITY

- **Never** work on vehicle with lifted tipping body without CORRESPONDING SUPPORT. All safety standards related to stability when tipping valid for drivers are equally valid for serviceman and mechanics.
- **Always** check and grease all hinges and pistons during REGULAR INSPECTIONS. Make sure all hose connections are in good condition and proper connection and liquid does not leak. Hydraulic liquid can cause health problems, endanger environment and must not leak from closed system.
- **Always** check if hydraulics hoses are not swollen and if they do not rub against bodywork.
- **Regularly** check if there are not any sharp parts protruding out of the bodywork that could injure around walking people or construction site employees. Make sure sealing round tailgate is in good condition and material can not leak after it is closed.
- **Always** check if vehicle's rear lights are not damaged after tipping or driving in terrain.
- **Always** use only authorized supplier for all parts necessary for piston repair or renewal. Make sure all sealings are delivered in original closed package marked by producer.

## INSTRUCTIONS FOR TIPPING BODIES SPARE PARTS PURCHASE

- **Always** use first quality parts from authorized suppliers. HYVA long-term experiences in the branch ensure to produce and supply only components corresponding with all safety standards.
- **PISTONS:** High-quality pistons' steel casings DOM and increased cylinder wall strength mean greater stability and optimal resistance when tipping to side
- **HOSES:** safety coefficient is 4:1 for all high-pressure hoses
- **VALVES:** integral damping valves prevent from formation of shock overpressure and manual governor enables to adjust the safest speed of rear tipping.
- **AIR CONTROL:** automatic PTO switch off prevents from excessive PTO wear and tear and secures this device is not powered when the vehicle is in motion.

### Voice signalling during manipulation with VS-mont tipping body



To increase safety when manipulating the tipping bodies, the company VS-mont installs signalling bleep alarm on all types of tipping bodies.

The driver and around standing people are warned by signalling bleep alarm in the moment when the manipulation with tipping body is initialized, as follows in the below mentioned cases:

- when lifting and lowering the tipping body in the direction to sides and backwards,
- when opening and closing hydraulically controlled sidewall,
- when the tipping body remains lifted due to maintenance, but it is not secured with support.

The driver is warned by signalling when the tailgate is unsecured (in the case that the tailgate is unlocked by means of pneumatic pistons).

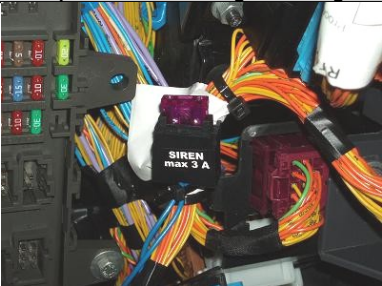
Signalling is connected through a fuse (3A).

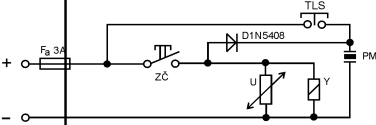
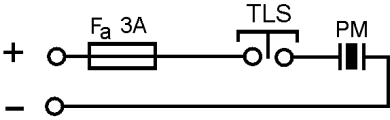
TYPE	With pneumatic unlocking of the tailgate	With mechanical (hydraulic) unlocking of the tailgate
Fuse location on the vehicle by the tipping bodies:	 <p>– fuse box</p>	 <p>– battery space</p>
Electrical connection diagram:		

F <sub>a</sub> – fuse 3A/32V	D – diode 1N5408
TLS – pressure switch 4 bar	U – varistor JVR05N390K
PM – alarm A – ST810 – 24V	Y – electromagnetical valve coil
ZC – switch for back face opening	

## **HEATING OF THE TIPPING BODY (IF AVAILABLE, OPTIONAL EQUIPMENT)**

There is a flap (lever) of the heating marked in the Figure 1, with which is regulated hot exhaust gas into the exhaust silencer or into tipping body.

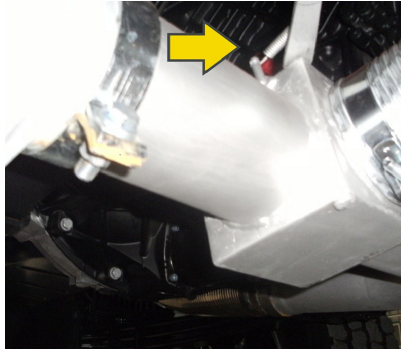

Picture 1

Following is the gas conducted through the line shown in Figure No. 2 and through bearing mechanism (Picture 3) into ventholes in the tipping body.

Picture 2



Picture 3



**The possibility of such design belongs to the accessories for extra charge**

# Service centres of the company VS-mont

(FOR REGULAR OBLIGATORY SERVICE INSPECTIONS)

We provide you with more information about the concrete service center in Slovak or Czech Republic or in other countries on the phone number below or on our website

[www.vsmont.sk](http://www.vsmont.sk)

## Slovakia

### **VS-mont s.r.o.**

Panština 1030  
020 55 Lazy pod Makytou  
Tel.: +421 42 4313 511  
Fax: +421 42 4313 516

[vsmont@vsmont.sk](mailto:vsmont@vsmont.sk)

[www.vsmont.sk](http://www.vsmont.sk)

### **VS-mont s.r.o. – Závod 02**

Robotnícka ulica 2125  
Areál Považských strojární  
017 01 Považská Bystrica  
Tel.: +421 42 4313 511  
Fax: +421 42 4313 516

[vsmont@vsmont.sk](mailto:vsmont@vsmont.sk)

[www.vsmont.sk](http://www.vsmont.sk)

## Romania

### **SC VS-mont, SRL**

STR.CONSTRUCTORILOR NR 21  
550 104 SIBIU  
TEL/FAX: 0269 / 24 24 74

[www.vsmont.ro](http://www.vsmont.ro)

## Hungary

### **EURO 3 HUNGÁRIA KFT**

József Attila u.14.  
2900 Komárom  
Tel: +36-20-232-5254

[info@euro3hungaria.hu](mailto:info@euro3hungaria.hu)

## Germany

### **Margaritis-Trucks GmbH**

Niederkasseler Str.13  
511 47 Cologne  
Telefon: +49(0)2203/9633-14

<http://www.margaritis.de>

## Bulgaria

### **CLEANMAT BULGARIA**

9. Tsvetan Minkov Str.  
1202 Sofia  
Tel.: +35 92 931 09 50

[cleanmat@mtel.net](mailto:cleanmat@mtel.net)

## Norway

### **Slaatta Transport v/**

#### **Arild Slaatta**

Orvella Industriomrade  
3692 Sauland  
Tlf: 0047/350 28800